

K e g i o m
l i f t i n g



trackedaccess

Access & Lifting Specialists

Model 200 Panda

ELECTRIC - PICK AND CARRY

gru - crane - kran - grue - grúa



www.trackedaccess.com



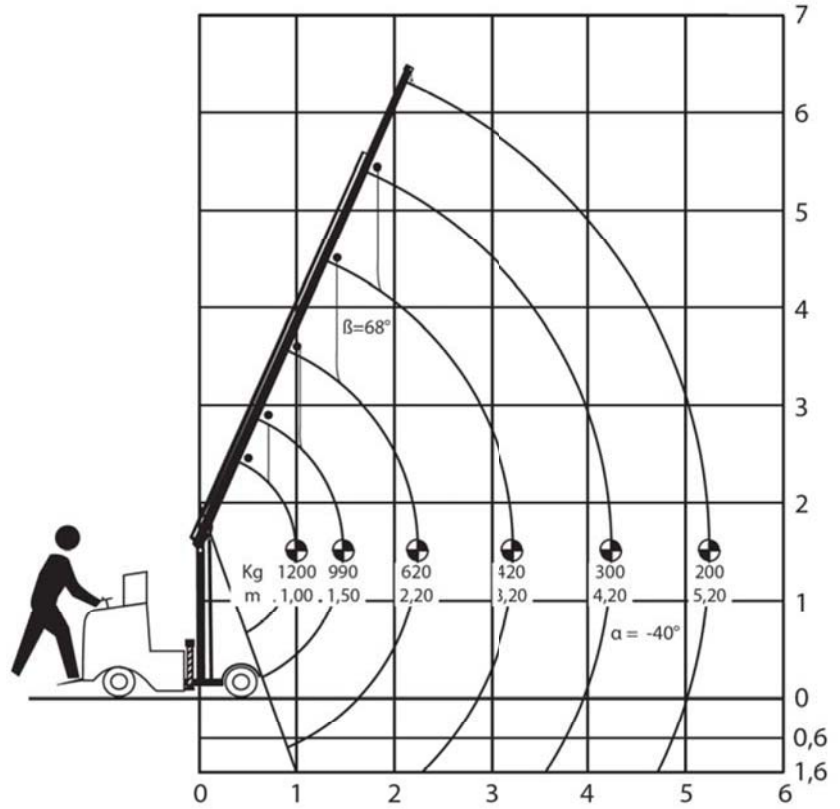

Tabella portata - Lifting Capacity Chart - Tableau de Charge - Hublasttabelle - Tablero de Carga

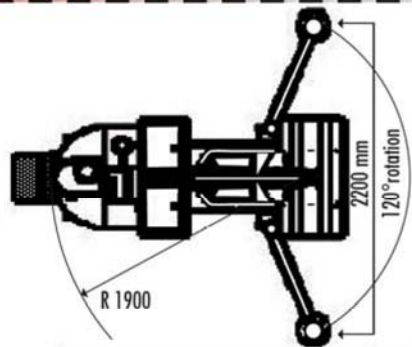
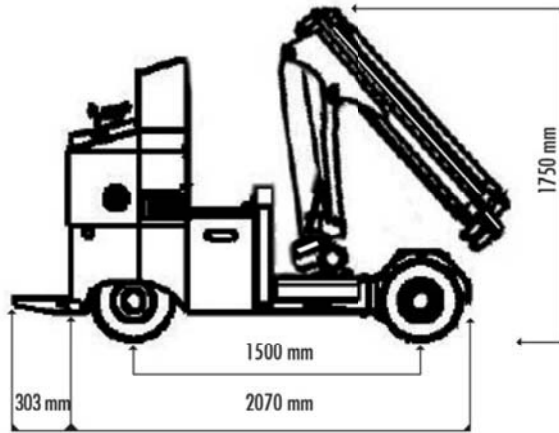









Dimensioni Generali - General Dimension - Dimensions Générales Gesamtabmessungen - Dimensiones Generales



DATI TECNICI – TECHICAL SHEET – TECHNISCHE DATEN – CARACTERISTIQUES TECHNIQUES – DATOS TECNICOS

					
Motore	Motor	Motor	Moteur	Motor	24V - 300W 1600rpm
Batteria	Battery	Batterien	Baterie	Baterias	24V - 400Ah
Caricabatteria	Battery charger	Batterielader	Baterie charge	Cargador de baterías	220 V - 24 V, 30A
Trazione idraulica con differenziale ruote anteriori	Hydraulic traction with differential anterior wheels	Wasser zug mit Differential vorder Rädern	Traction hydraulique avec différentielles roues antérieures	Tracción hidráulica con diferenciales ruedas anteriores	Velocità - Travel speed - 0-3 km/h Geschwindigkeit - 0 Puissance - Velocidad 0-5 km/h
Comando sterzo	Steering control	Steuerungen Lenkung	Commande direction	Mandos dirección	Idrosterzo - Hydraulic steering - Servolenkung - Direction hydraulique - dirección hidráulica
Ruote posteriori e ruote anteriori	Back wheels and front wheels	Hinterrad und vorderad	Roues arrière et roues avant	Ruedas posterior y ruedas anterior	16x6x8" Superelastische - Superelastic - Supera- stisch - Superelastique - Superelástico
Portata max	Max lifting	Max.Tragfähigkeit	Capacité maximum	Carga máxima	1200 Kg.
Sbraccio massimo	Max working radius	Max.Ausladung	Longueur de flèche max	Alcance lateral máx.	5,20 m.
Altezza massima	Max.working height	Tragfähigkeit bei max.Ausladung	Hauteur de levage max.	Altura max. de trabajo	6,50 m.
Inclinazione braccio	Boom elevation	Auslegemeigung	Inclinaison de flèche	Inclinación de la pluma	-40° / +68°
Rotazione gru	Rotation crane	Umdrehung kran	Rotation grue	Rotación grúa	25°
Rotazione gru + Stabilizzatori	Rotation crane + Outriggers	Umdrehung kran + Abstützung	Rotation grue + Stabilisateurs	Rotación grúa + Estabilizadores	120°
Freno di servizio	Service brake	Betriebsbremse	Frein de service	Freno de servicio	Idraulico - Hydraulic - Hydraulische - Hydraulique - Hidráulico
Freno di stazionamento	Parking brake	Parkbremse	Frein de stationnement	Freno de estacionamiento	Mecanico sulle ruote anteriori - Mechanical on the anterior wheels - Mechanische auf die vorder Räder - Mécanique sur le roues antérieures - Mecánica sobre las ruedas anteriores
Limitatore di momento	Automatic limiting device	Automatische grenzlastregelung	Limiteur de charge	Limitador de momento	Elettronico - Electronic - Elektro- nisch - Électronique - Electrónico
Dimensioni gru	Dimensions crane	Abmessungen kran	Dimensions de la grue	Dimensiones grúa	2070 x 850 x 1750 mm.
Peso	Weight	Gewicht	Poids	Peso	1550 Kg.

OPTIONAL

 Verricello Winch Treuil Seilwinde Cabrestante	 Stabilizzatori Outriggers Astützung Stabilisateurs Estabilizadores	 Radiocomando Radio remote control Radiocommande Funkfernsteuerung Radiomando	 Trattamento marino delle gru Marine treatment of the crane Traitement marin de la grue Maritime Ausstattung des kranes Tratamiento especial marino de la grua
 Prolunghe meccaniche Manual extensions Rallonges manuelles Manuelle verlängerung Alargadores mecánicos	 Forche Forks Gabel Forche Hbrca	 Telecomando Cable remote control Télécommande Kabelfernsteuerung Control remoto por cable	 Cestello Basket Nacelle Personenkorb Cesta



trackedaccess

Access & Lifting Specialists

t: +44 (0) 845 603 5360

f: +44 (0) 845 603 5361

info@trackedaccess.com

www.trackedaccess.com